

**1" Dia. Grab Bar-Towel Bar with Flanges for Concealed Mounting - 36" [914] Length**

Grab Bars

MasterFormat Section 10 28 13



**SUSTAINABILITY/LEED**

MR 4.1 (1) MR 6 (1) EQ 4.2 (1)  
MR 4.2 (1) EQ 4.1 (1) EQ 4.4 (1)

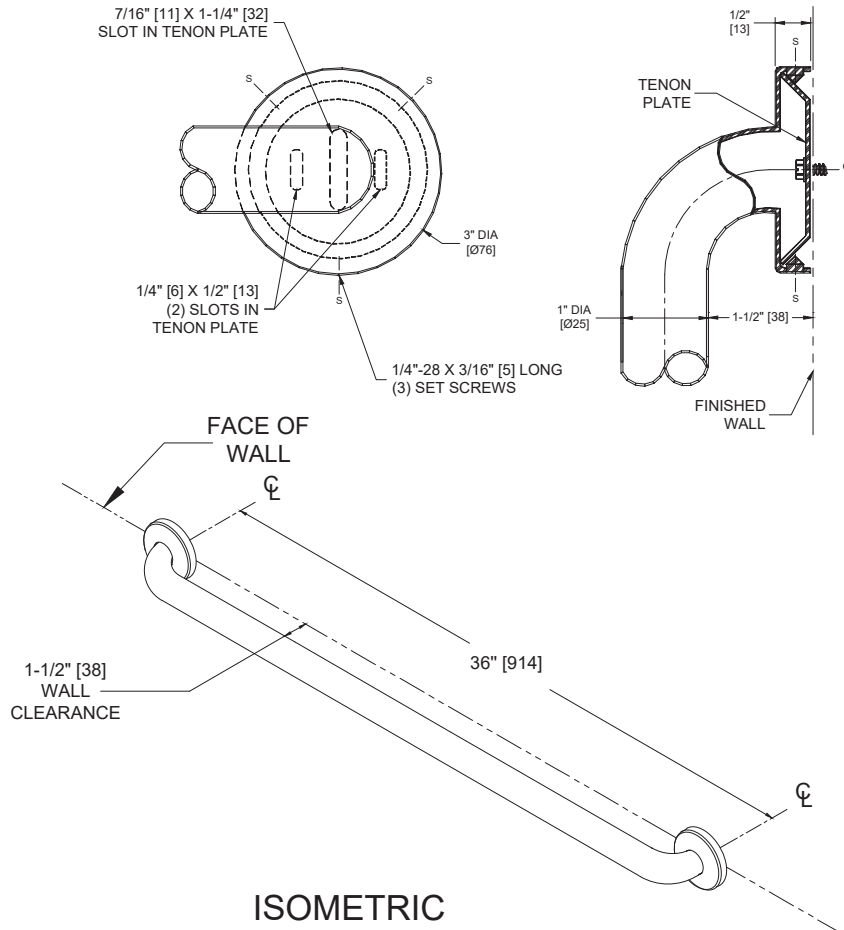

ISOMETRIC

**NOTE:**  
ALL DIM'S INCH [MM]  
ILLUSTRATION FOR REF ONLY AND NTS

**PRODUCT OVERVIEW**

Grab Bar-Towel Bar with Flanges for Concealed Mounting shall be type 304 stainless steel alloy 18-8. Tubing shall be 1" diameter [Ø25] x 18 gauge [1.2]. Flange shall be heliarc welded to tubing with a continuous concealed bead and shall be 11 gauge [3] thick. Three (3) tamper resistant 1/4-28 stainless steel hex socket set screws shall be supplied for each flange. Mounting Tenon plates shall be fabricated of case hardened cadmium plated 13 gauge [2.3] steel. 36" [914] length.

**KEY FEATURES & SPECIFICATIONS**

- Straight Grab Bar
- Concealed Flange - 3" diameter [Ø76], 1/8" [3] thick
- Type 304 Stainless Steel - Satin Finish
- Surface Mounted
- 1" Diameter [Ø25] Bar
- 36" [914] Length

***OPERATION & MAINTENANCE***

Stainless Steel washroom accessory products require regular surface cleaning, much the same as stainless steel sinks, pots and pans and eating utensils. As long as a regular cleaning schedule is followed, the best method is cleaning with a soft clean rag moistened with a mild detergent, followed by a water-moistened clean rag and then a dry rag. For a "new" look, surfaces can be wiped with lemon oil applied by a soft polishing cloth to maintain sheen. Stainless Steel should be protected against muriatic acid and caustic or abrasive materials, and harsh cleaning detergents [with pH outside the range  $7 \pm 1.5$ ]. In the event such agents cause discoloration, polishing with a stainless steel cleaner such as 3M™ Stainless Steel Cleaner & Polish® and a soft cloth on bright or mirror finishes, or for satin finish surfaces the Stainless Steel cleaner and 3M™ Scotch Brite® pad either blue (less aggressive) or green (more aggressive) is recommended.

***TECHNICAL INFORMATION / PRODUCT PROPERTIES***

<b>Property</b>	<b>Value</b>
Dimensions	36" [914] x 1" [25] dia. Bar x 3" [76] dia. Flange x 2-1/2" [63]
Construction	Type 304 Stainless Steel - Satin Finish 1" Outside Diameter [Ø25] Bar
Mounting	Surface Mounted
Capacity	ASI grab bars are designed to meet and exceed 2010 ADA Accessibility Standards and ANSI A117.1 that fabricated product shall be of adequate strength to support a load in excess of 250 pounds (113.4 kg). Mounting to the wall is a critical part of the system to meet this requirement. The fastener system must be adequately sized to withstand the shear, tension or pullout, and torsion loads generated by the maximum loading.

***INSTALLATION***

Tenon plates are secured to wall with a 1/4" bolt (by others) through an elongated slot that provides 1" [25] vertical range and 3/16" [5] horizontal range for fitting adjustment. Flanges are then fitted over Tenon plates and secured by tightening the hex socket set screws (provided). Appropriate anchoring and backing must be provided in accordance with local building codes or as specified prior to wall finishing. Anchors are available from ASI and must be specified separately.

Grab Bar Configurations <https://americanspecialties.com/wp-content/uploads/grabbarconfig.pdf>

***WARRANTY***

One (1) Year from date of Invoice