

1-1/4" Dia. Exposed Mount Grab Bar - 30" [762] Length

Grab Bars

MasterFormat Section 10 28 13

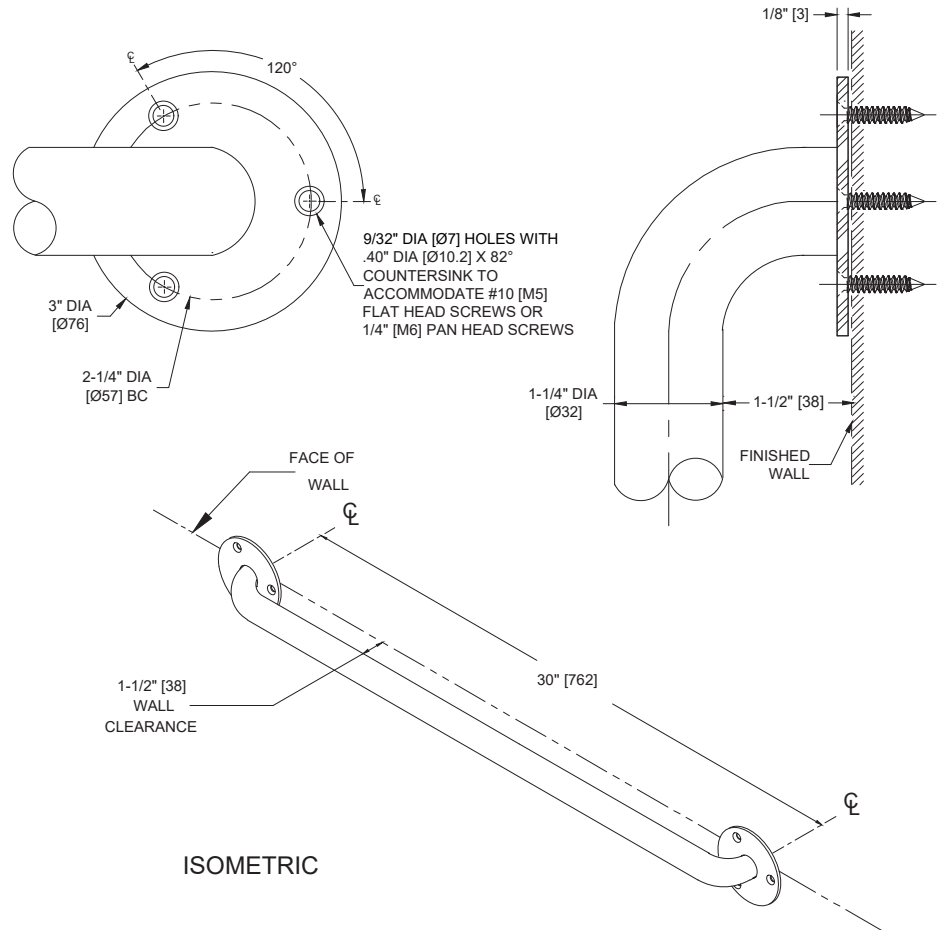

ISOMETRIC

NOTE:
ALL DIM'S INCH [MM]
ILLUSTRATION FOR REF ONLY AND NTS

SUSTAINABILITY/LEED

MR 4.1 (1) MR 6 (1) EQ 4.2 (1)
MR 4.2 (1) EQ 4.1 (1) EQ 4.4 (1)

PRODUCT OVERVIEW

Features include flange of 3" diameter [Ø76], 1/8" [3] thick type 304 stainless steel with a satin finish; exposed mounting screw holes are drilled and countersunk. 1-1/4" diameter [Ø32] bar with smooth surface.

KEY FEATURES & SPECIFICATIONS

- Straight Grab Bar
- Exposed Flange - 3" diameter [Ø76], 1/8" [3] thick
- Type 304 Stainless Steel - Satin Finish
- Surface Mounted
- 1-1/4" Outside Diameter [Ø32] Bar
- 30" [762] Length

OPERATION & MAINTENANCE

Stainless Steel washroom accessory products require regular surface cleaning, much the same as stainless steel sinks, pots and pans and eating utensils. As long as a regular cleaning schedule is followed, the best method is cleaning with a soft clean rag moistened with a mild detergent, followed by a water-moistened clean rag and then a dry rag. For a "new" look, surfaces can be wiped with lemon oil applied by a soft polishing cloth to maintain sheen. Stainless Steel should be protected against muriatic acid and caustic or abrasive materials, and harsh cleaning detergents [with pH outside the range 7 ± 1.5]. In the event such agents cause discoloration, polishing with a stainless steel cleaner such as 3M™ Stainless Steel Cleaner & Polish® and a soft cloth on bright or mirror finishes, or for satin finish surfaces the Stainless Steel cleaner and 3M™ Scotch Brite® pad either blue (less aggressive) or green (more aggressive) is recommended.

TECHNICAL INFORMATION / PRODUCT PROPERTIES

Property	Value
Dimensions	1-1/4" Outside Diameter [Ø32] Bar / 30" [762] Length
Construction	Type 304 Stainless Steel - Satin Finish 1-1/4" Outside Diameter [Ø32] Bar
Mounting	Surface Mounted
Capacity	ASI grab bars are designed to meet and exceed 2010 ADA Accessibility Standards and ANSI A117.1 that fabricated product shall be of adequate strength to support a load in excess of 250 pounds (113.4 kg). Mounting to the wall is a critical part of the system to meet this requirement. The fastener system must be adequately sized to withstand the shear, tension or pullout, and torsion loads generated by the maximum loading.

INSTALLATION

Use grab bar as template to mark mounting holes locations and pre-drill holes. Install bar using three (3) #10 self-threading flat head or oval head screws (by others) or other fastener system (by others) to suit conditions for each flange. Appropriate anchoring and backing must be provided in accordance with local building codes or as specified on Architects Plans prior to wall finishing. For compliance with 2010 ADA Accessibility Standards install unit so that the top of the grab bar is 33" [840] minimum Above Finished Floor (AFF) to 36" [915] maximum AFF. Anchors are available from ASI and must be specified separately for each grab bar style scheduled (see 3900 series).

Grab Bar Configurations <https://americanspecialties.com/wp-content/uploads/grabbarconfig.pdf>

WARRANTY

One (1) Year from date of Invoice