

Mop Rack - (5 Holders) 46" – Surface Mounted

Custodial Accessories

MasterFormat Section 10 28 13

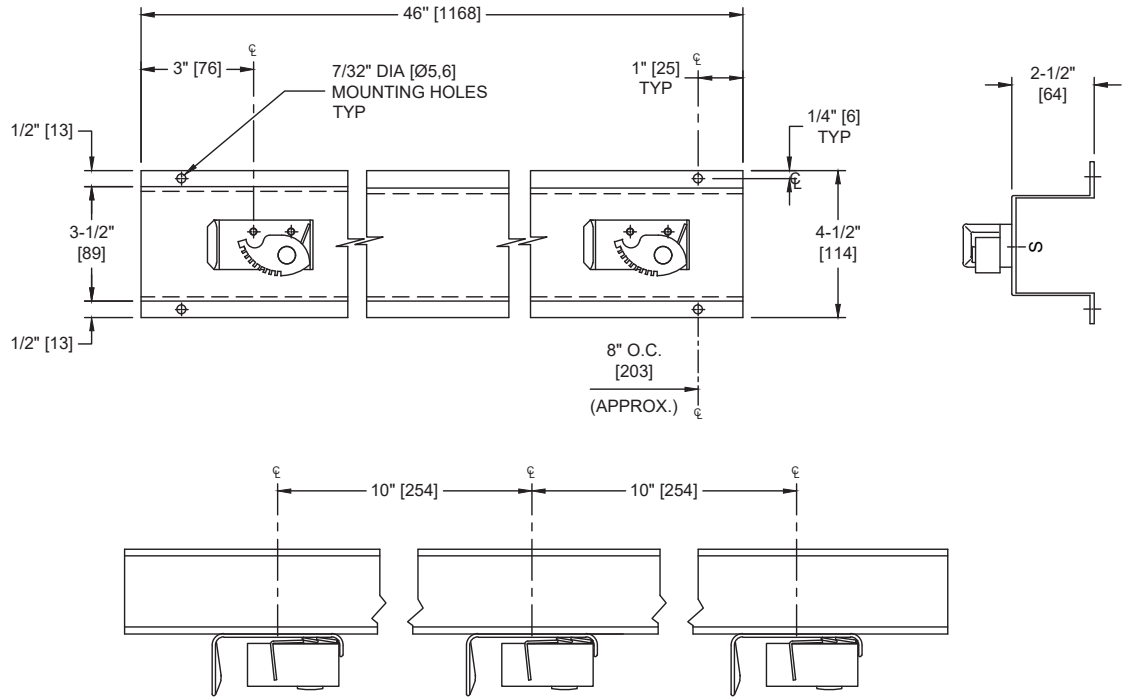

Scan for Information



SUSTAINABILITY/LEED

MR 4.1 (1) MR 6 (1) EQ 4.2 (1)
MR 4.2 (1) EQ 4.1 (1) EQ 4.4 (1)

NOTE:
ALL DIM'S INCH [MM]
ILLUSTRATION FOR REF ONLY AND NTS

PRODUCT OVERVIEW

Formed channel fabricated of 20 gauge, type 304 stainless steel satin finish. Projects 3-1/2" [90] from wall. Rubber cam holders ribbed for grasping. 5 holders, 46" [1168] long.

KEY FEATURES & SPECIFICATIONS

- 5 Holders
- Pivoting spring loaded holders have serrated rubber cams for grasping.
- Type 304 Stainless Steel - Satin Finish
- Surface Mounted
- 46" [1168] Length

OPERATION & MAINTENANCE

Mop or broom handle is pushed into grip-jaw of pivoting serrated rubber cam with upward motion until it seats behind rib on clamp plate. Spring holds cam against handler. Gravity holds mop clamped in position.

TECHNICAL INFORMATION / PRODUCT PROPERTIES

Property	Value
Dimensions	46" [1168] W x 4-1/2" [114] H x 2-1/2" [64] D
Construction	Type 304 Stainless Steel - Satin Finish
Mounting	Surface Mounted
Capacity	5 Holders

INSTALLATION

For general utility mount rack 70" [1778] Above Finished Floor (AFF) from bottom of rack with #10 self-threading pan head screws (by others) through holes provided. For compliance with 2010 ADA Accessibility Standards install unit so that top of hook is 48" [1219] maximum AFF.

WARRANTY

One (1) Year from date of Invoice